

www.worky-italy.com

 BANCHI

 BENCHES

 BANCS

 ÄBSAUGTISCHE

 BANCOS

WORKY[®]

SAB



 I banchi aspiranti SAB con il piano di lavoro in lamiera forata sono ideali per lavorazioni metalliche con produzione di fumi o polveri. L'aspirazione dal basso o dalle pareti laterali evita che l'operatore venga investito dai fumi inquinanti. Il filtro in paglia metallica, unitamente alla barriera superiore, distribuisce uniformemente l'aspirazione e convoglia le parti più grossolane nel cassetto di raccolta e il restante fumo viene aspirato da apposito impianto filtro-aspirante. La robusta costruzione unitamente alla pregevolezza delle finiture rendono il banco della linea SAB un valido supporto all'operatore professionale.

 SAB suction benches with perforated sheet metal work surface are ideal for metalworking with smoke or dust production. The aspiration from the bottom or side walls prevents the operator from being polluted by hazardous fumes. The metallic mesh filter, together with the upper barrier, distributes suction evenly and conveys the coarsest parts into the extractable drawer and the remaining smoke is sucked out by a dedicated suction-filtering system. The rugged construction combined with the high finishing touch make the SAB line a solid support for the professional operator.

 Les tables aspirantes SAB avec surface de travail en tôle perforée sont idéales pour le travail des métaux avec production de fumée ou de poussière. L'aspiration du fond ou des parois latérales empêche l'opérateur d'être pollué par des fumées dangereuses. Le filtre à mailles métalliques, associé à la barrière supérieure, distribue l'aspiration uniformément et achemine les pièces les plus lourdes dans le tiroir du fond et la fumée restante doit être aspirée par un système de filtrage dédié. La construction robuste combinée à la haute finition font de la ligne SAB un support solide pour l'opérateur professionnel.

 SAB-Absaugtische mit Lochblech-Arbeitsfläche sind ideal für die Metallbearbeitung mit Rauch- oder Staubproduktion. Die Absaugung aus der Unterseite oder den Seitenwänden verhindert, dass der Bediener durch gefährliche Dämpfe verunreinigt wird. Der Metallgitterfilter verteilt, zusammen mit der oberen Barriere, die Saugwirkung gleichmäßig und fördert die größten Teile in die herausziehbare Schublade. Der verbleibende Rauch wird durch ein spezielles Saugfiltersystem abgesaugt. Die robuste Konstruktion kombiniert mit dem hohen Feinschliff, machen die SAB-Linie zu einer soliden Unterstützung für den professionellen Anwender.

 Los bancos aspirantes SAB con superficie de trabajo de chapa perforada son ideales para procesos con producción de humo o polvo. La aspiración desde la parte inferior o las paredes laterales evita que el operador sea contaminado por humos peligrosos. El filtro de malla metálica, junto con la barrera superior, distribuye la aspiración de manera uniforme y transporta las partes más gruesas en el cajón extraíble y el humo restante es aspirado por un sistema de filtración y succión dedicado. La construcción robusta combinada con el alto toque final hace que la línea SAB sea un soporte sólido para el operador profesional.

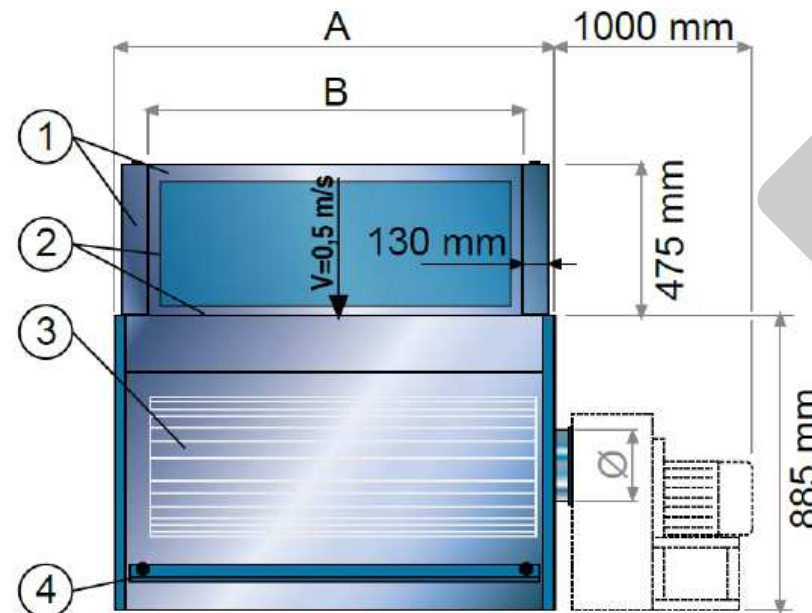
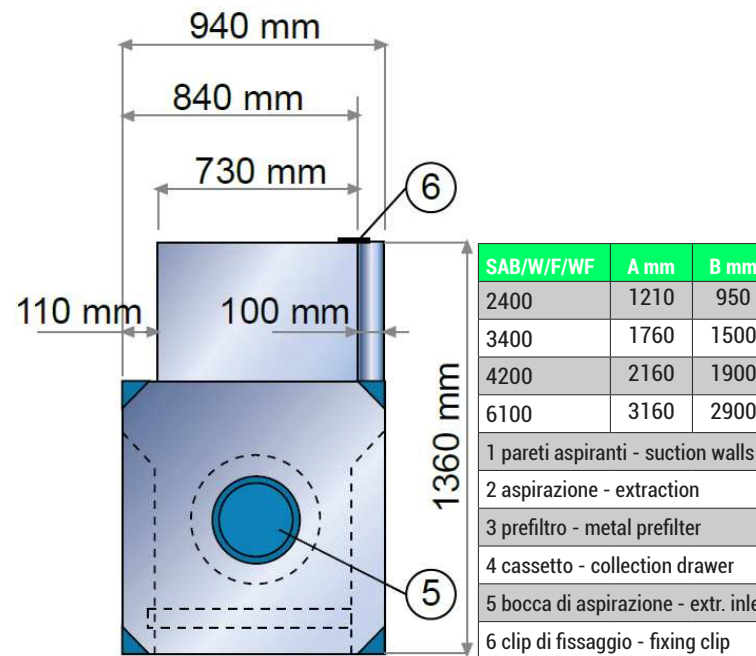

SAB





SAB	m³/h	dimens. (mm)	ø out	Kw	HP
SAB2400	2.400	1210 x 940 x H885	250	-	-
SAB3400	3.400	1760 x 940 x H885	300	-	-
SAB4200	4.200	2160 x 940 x H885	350	-	-
SAB6100	6.100	3260 x 940 x H885	400	-	-

 Banco aspirante per fumi di saldatura e polveri di smerigliatura leggera con prefiltra in paglia metallica.

 Welding fumes and light grinding dusts extracting bench with metal pre-filter.

 Table aspirante pour fumées de soudure et poussières de grincement équipée avec pre-filtre métallique.

 Absaugtisch geeignet für die Absaugung von Schweißrauch und Stäuben. Ausgestattet mit metallischem Vorfilter.

 Banco aspirante para humos de soldadura y polvos de amoladura con prefiltra metálico.

SAB-F





SAB-F	m³/h	dimens. (mm)	ø out	Kw	HP
SAB2400-F	2.400	2210 x 940 x H885	250	1,1	1,5
SAB3400-F	3.400	2760 x 940 x H885	300	1,5	2
SAB4200-F	4.200	3160 x 940 x H885	350	2	3
SAB6100-F	6.100	4260 x 940 x H885	400	3	4

 Banco aspirante per fumi di saldatura e polveri di smerigliatura leggera con prefiltra in paglia metallica e aspiratore integrato.

 Welding fumes and light grinding dusts extracting bench with metal pre-filter and fan.

 Table aspirante pour fumées de soudure et poussières de grincement équipée avec pre-filtre métallique et ventilateur.

 Absaugtisch geeignet für die Absaugung von Schweißrauch und Stäuben. Ausgestattet mit metallischem Vorfilter und Ventilator.

 Banco aspirante para humos de soldadura y polvos de amoladura con prefiltra metálico y aspirador.

SAB-W





SAB-W	m³/h	dimens. (mm)	ø out	Kw	HP
SAB2400-W	2.400	1210 x 940 x H1360	250	-	-
SAB3400-W	3.400	1760 x 940 x H1360	300	-	-
SAB4200-W	4.200	2160 x 940 x H1360	350	-	-
SAB6100-W	6.100	3260 x 940 x H1360	400	-	-

 Banco aspirante per fumi di saldatura e polveri di smerigliatura leggera con pareti laterali e prefiltra in paglia metallica.

 Welding fumes and light grinding dusts extracting bench with lateral walls and metal pre-filter.

 Table aspirante pour fumées de soudure et poussières de grincement équipée avec parois latérales et pre-filtre métallique.

 Absaugtisch geeignet für die Absaugung von Schweißrauch und Stäuben. Ausgestattet mit metallischem Vorfilter und seitlichen Wände.

 Banco aspirante para humos de soldadura y polvos de amoladura con prefiltra metálico y paredes laterales.

SAB-FW

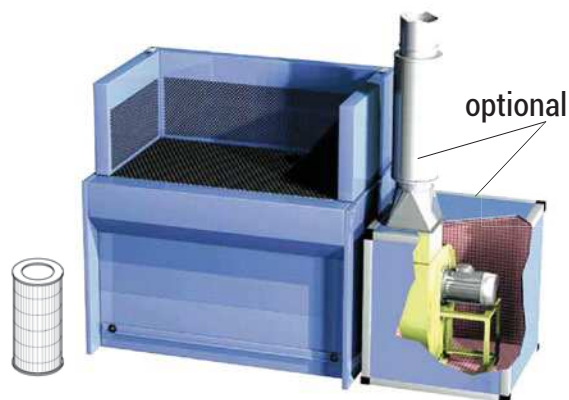



SAB-FW	m³/h	dimens. (mm)	ø out	Kw	HP
SAB2400-FW	2.400	1210 x 940 x H1360	250	1,1	1,5
SAB3400-FW	3.400	1760 x 940 x H1360	300	1,5	2
SAB4200-FW	4.200	2160 x 940 x H1360	350	2	3
SAB6100-FW	6.100	3260 x 940 x H1360	400	3	4

 Banco aspirante per fumi di saldatura e polveri di smerigliatura leggera con pareti laterali, prefiltra in paglia metallica e aspiratore.

 Welding fumes and light grinding dusts extracting bench with lateral walls, metal pre-filter and fan.

 Table aspirante pour fumées de soudure et poussières de grincement équipée avec parois latérales, pre-filtre métallique et aspirateur.

 Absaugtisch geeignet für die Absaugung von Schweißrauch und Stäuben. Ausgestattet mit metallischem Vorfilter, seitlichen Wände und Ventilator

 Banco aspirante para humos de soldadura y polvos de amoladura con prefiltra metálico, paredes laterales y aspirador.

